



Standard Prices for Generator Connections 2023

Revision Date: 2023

Issued by: ESB NETWORKS DAC

Document Number: DOC-050110-AXU

Revision: 13

Approved by: CRU

Effective Date: 01/01/2023

**Regulation and Commercial
Network Assets
ESB Networks DAC
Distribution System Operator**

CONTENTS

1.0 Introduction	3
2.0 Standard Pricing Approach	4
2.1 Standard Pricing Process.....	4
2.2 Pass through Costs	5
2.3 Proposed Amendments to Current Charges.....	6
SCHEDULE 1: CHARGES FOR GENERATORS EXCL VAT.....	7
Schedule 1a: Line Standard Charges	10
Schedule 1b: Cable Standard Charges	12
Schedule 1c: 110 kV Station Standard Charges	14
Schedule 1d: 38kV Station Standard Charges.....	21
Schedule 1e: Miscellaneous Station Standard Charges.....	30
Schedule 1f: Metering Standard Charges	35
Schedule 1g: Communications & Protection Standard Charges.....	36
Schedule 1h: 38 kV Customer Compound [At Generator Site] Standard Charges	38

1.0 INTRODUCTION

A key principle of the Group Processing Approach (and non-Group Processing Approach) for the DSO connections and the provision of connection offers in a timely manner is the implementation of the Standard Pricing approach. Under this approach a standard price for the main items on which such connection offers were based was approved by the then Commission for Energy Regulation in its Decision paper, Standard Pricing Approach for Connecting Renewable Generators to the Distribution Networks (CER/05/090). These standard prices were based on 2007 costs.

The DSO subsequently agreed with the CRU that these charges should be updated on an annual basis; this was initially based on forecast CPI and in 2010 it was agreed that they should be updated based on forecast HICP from 2011 onwards. In addition, DSO revised the charges to reflect any over or underestimates in forecasts for CPI and HICP estimates used in the previous year's costs.

While in recent years the charges were indexed, a full review of the charges had not taken place since 2007. The DSO undertook to complete a full review of the charges from 2018 to 2020, based on the most up-to-date information available, experience of actual costs in relation to the procurement of equipment and undertaking connection works along with reviewing the scope of works included within the Standard Charges. During the review, the DSO identified a number of charges which were not in use and proposed to discontinue these. On 16th April 2021, CRU published a decision paper (CRU/21/035) on ESB Networks 2020 proposals for changes to Generator Standard Charges (GSCs). The new list of approved Standard Charges document was published alongside the decision. The Standard Charges have been updated based on forecast HICP. The Commission has approved these updated Standard Charges under Section 36 of the Electricity Regulation Act, 1999.

As part of the review of the Standard Charges, many of the charges now include an SLD in addition to identifying what is included and excluded from the scope. In general, civil costs are not included in the Standard Charges and will be charged on a pass through basis as per section 2.2 below.

2.0 STANDARD PRICING APPROACH

The application of the standard pricing approach, as outlined below, is the most effective and equitable means of processing the applications while facilitating the provision of DSO connection offers in a timely manner. For avoidance of doubt, this approach applies to both the shared and dedicated connection assets for generators. The standard pricing process and charges are outlined below.

2.1 STANDARD PRICING PROCESS

1. The DSO connection offer pricing is based upon a desktop study plus site visit to estimate the volume and type of material required.
2. The proposed connection is then costed using the schedule of charges detailed in Schedule 1.
3. Costs are attributed to the various generators in a Group/ Subgroup (by the relevant System Operator) on the basis of the charging regime outlined in the Joint TSO/DSO Group Processing Approach Charging and Rebating Principles 17th June 2010.
https://www.cru.ie/document_group/system-operator-gpa-pricing-principles-and-losses-policy-for-generators/joint-tso-and-dso-group-processing-approach-charging-and-rebating-principles/
4. Following acceptance of the connection offer, scoping of the project commences and planning permission and consents are obtained.
5. Costs identified as pass-through (see section 2.2) at the desktop study stage will be estimated and included in the connection offer. Over the course of the project, as the extent of these costs become clearer the estimates shall be revised. The final charge for pass through costs is known post energisation so that their costs can be included in the final payment.
6. All pass through cost included in the customer's offer are based on the information available at the time of offer study. Following scoping and detailed design and construction, these pass through costs shall be further defined and communicated to the customer via their stage payment invoices.

2.2 PASS THROUGH COSTS

The Generator is advised that certain costs are pass-through (“Pass Through Costs”) from the System Operator to the Generator who will be responsible for their payment in full. These costs are a non-exhaustive exclusion from the Standard Charge. The majority of these costs will be determined at the scoping, detailed design and construction phases of the System Operator’s Connection Works and will be advised to the Generator at these points. However, where feasible, an estimate of these costs, or information which may allow the Generator estimate the costs, will be provided at connection offer stage on the basis that such estimates or information are not an obligation by the System Operator to commit to these estimates or information.

The following are a non-exhaustive list of Pass Through Costs i.e. costs that are excluded in the Standard Charges contained in this paper but which may be charged to the Generator:

- ✓ Civil Works: All civil works have been excluded from the 2023 GSCs with the exception of charges relating to OHL works (GSC 5, 7 & 12) where the costs of pole / mast foundations have been included as they are inherent in the pole / mast installation works in these charges. Note: 4 GSC’s (13, 14, 24 & 34) are identified as civils only for refund purposes, and these costs are purely civils in nature;
- ✓ Civil design fees, supervision and all other associated costs;
- ✓ Site purchase and associated costs, charges and fees;
- ✓ Site enabling works – preparatory works required in advance of the Generator’s connection works, such as, but not limited to relocation of existing services e.g. overhead or underground services, and/or demolition works, removal of contaminated material etc.;
- ✓ Volume changes – where the detailed design gives rise to a longer (or shorter) line route than originally envisaged the associated charge will be adjusted accordingly. In addition, any change in the ratio of overhead line to cable will lead to an adjustment;
- ✓ Planning fees / Consents – e.g. costs associated with serving and enforcement of Consents including without limitation costs associated with planning permissions, changes to routes etc.;
- ✓ Legal costs associated with asset transfer;
- ✓ Wayleaves and Consents compensation
- ✓ Land damage payments made to landowners due to ESB Networks accessing property or land compensation;
- ✓ Temporary generation and/or any temporary equipment such as a temporary transformers, mobile bays and any associated works/costs if required to facilitate the Generator’s connection;
- ✓ Working outside normal working hours where deemed necessary to facilitate the customer’s connection works;
- ✓ Any pass-through costs advised by TSO
- ✓ Cable testing;
- ✓ Security – cost of security which is required e.g. at stations to prevent material theft;

- ✓ Additional costs associated with access to the works, and transporting materials and labour to same due to abnormal ground or site conditions, environmental constraints and the like;
- ✓ Abnormal ground or site conditions in regard to, but not limited to: rock, peat, surface and or ground water; bridge, river crossings, forestry etc;
- ✓ Outage constraints;
- ✓ Forestry – costs associated with forestry compensation;
- ✓ Cost of road opening licenses where cable works are undertaken by the ESB Networks;
- ✓ Lock out costs - where DSO staff and/or their contractors are prevented from accessing a site where customer's connection works are due to be undertaken.

2.3 AMENDMENTS TO CURRENT CHARGES

GSC's which are not outlined above will not be maintained as standard charges and are noted as "Discontinued" in summary tables GSC's for information purposes.

SCHEDULE 1: CHARGES FOR GENERATORS EXCL VAT

Standard Charges Summary			
Ref	Description	Standard Charge	Contestable
1	110 kV SC Woodpole 300 mm ² ACSR 80°C	Discontinued	
2	110 kV SC Woodpole 430 mm ² ACSR (< 10 km) 80°C (New Build only)	Discontinued	
3	110 kV SC Woodpole 430 mm ² ACSR (> 10 km) 80°C (New Build only)	Discontinued	
4	38 kV SC Woodpole 300 mm ² ACSR 60°C	Discontinued	
5	38 kV SC Woodpole 150 mm ² AAAC 80°C	€101,330	Yes
6	38 kV SC Woodpole 100 mm ² ACSR 60°C	Discontinued	
7	MV SC Woodpole 150 mm ² AAAC / 92 mm ² SCA 65°C	€53,330	Yes
8	110 kV – 630 mm ² XLPE (AL) Single Circuit	€390,150	Yes
9	38 kV – 630 mm ² XLPE (AL) Single Circuit	€128,510	Yes
10	MV – 400 mm ² XLPE (AL) Single Circuit	€40,160	Yes
11	38 kV Cable End Mast	Discontinued	
12	110 kV Cable End Mast	€254,190	Yes
13a	110 kV Cable Civils (for refund purposes only)	€361,060	Yes
13b	38 kV Cable Civils (for refund purposes only)	€235,350	Yes
14	MV Cable Civils (for refund purposes only)	€166,170	Yes
15	New 110 kV AIS “H-Type” Single Busbar Outdoor Station (Strung Busbar)	Discontinued	
16	New Tail-fed (Single Supply) Outdoor AIS 110 kV Station (Strung Busbar)	Discontinued	
17	New 110 kV/MV Station (excluding Site Purchase & Civil Works)	Discontinued	
18	110 kV/38 kV 63 MVA Green Field Transformer Package	€1,787,950	Yes
19	110 kV/38 kV 31.5 MVA Green Field Transformer Package	€1,472,180	Yes
20	110 kV/MV 20 MVA Green Field Transformer Package	€1,176,870	Yes

Ref	Description	Standard Charge	Contestable
21	110 kV/MV 31.5MVA Green Field Transformer Package	€1,353,730	Yes
22	Uprate 1*31.5 MVA to 2*31.5 MVA Substation	Discontinued	
23	Uprate 2*31.5 MVA to 2*63 MVA Substation	€3,785,390	No
24	Civil works for a Typical Outdoor 110 kV Station Based on the layout of Item 15 (for refund purposes only)	€1,148,040	Yes
25	New 2*5 MVA Station	Discontinued	
26	5 MVA 38 kV/MV Green Field Transformer Package	€833,270	Yes
27	10 MVA 38 kV/MV Green Field Transformer Package	Discontinued	
28	15 MVA 38 kV/MV Green Field Transformer Package	€1,047,000	Yes
29	Install 5 MVA 38 kV/MV Transformer into Existing Station with 38 kV Busbar Extension	€873,120	No
30	Install 10 MVA 38 kV/MV Transformer into Existing Station with 38 kV Busbar Extension	€956,880	No
31	Install 5 MVA 38 kV/MV Transformer into Existing Station without 38 kV Busbar Extension	€809,130	No
32	Install 10 MVA 38 kV/MV Transformer into Existing Station without 38 kV Busbar Extension	€892,900	No
33	Uprate 2*5 MVA Station to 2*10 MVA	€2,014,780	No
34	Civil Works for a Typical Outdoor 38 kV Station (for refund purposes only)	€647,060	Yes
35	New 110 kV AIS Line bay in existing 110 kV Single Busbar Outdoor Station	747,180	No
36	38 kV Cubicle in 38 kV Station	€275,450	No
37	38 kV Cubicle in 110 kV Station	€318,280	No
38	MV Cubicle in 110 kV or 38 kV Station	€219,090	No
39	MV Cubicle with Interface Transformer	Discontinued	
40	Half MV busbar	Discontinued	
55	Installation of 110kV NVD (Neutral Voltage Displacement) Protection (on both Transformers) <i>New GSC proposed</i>	€198,430	No

Ref	Description	Standard Charge	Contestable
41	38 kV Meter and Power Quality	€57,550	No
42	MV Metering and Power Quality < 10 MVA	€27,870	No
43	MV Metering and Power Quality < 10 MVA (where MV CB is being charged as part of EGIP installation, no need for KKK)	€21,380	No
44	MV Metering and Power Quality >= 10 MVA	€29,600	No
45	MV Metering and Power Quality >= 10 MVA (where MV CB is being charged as part of EGIP installation, no need for KKK)	€23,090	No
46	Protection Implementation for MV Connections with MEC < 2 MW	€42,420	No
47	SCADA & Communications Implementation for MV Connections with MEC >=2MW	€61,900	No
48	SCADA Implementation for 38 kV Connections between 2 MW and 5 MW (and MV connections >= 2 MW and < 5 MW where there is no GPRS Coverage)	Discontinued	
49	Protection & Switchgear for Standard MV Connection (Basic G10 type Connection)	€55,070	No
50	Switchgear & Embedded Generation Interface Protection (EGIP) for an MV Connection (Full fit-out of Generator Sub Connection)	€224,560	Yes
50a	Switchgear & Embedded Generation Interface Protection (EGIP) for an MV Connection, Standard Module Substation	€287,010	No
51	Embedded Generation Interface Protection (EGIP) for a 38 kV Connection	€89,040	Yes
52	Embedded Generation Interface Protection (EGIP) for a 110 kV Connection	€96,550	Yes
53	ESB Networks Compound with Over-the-Fence Connection to Developer – Overhead Connection	€575,020	Yes
54	ESB Networks Compound with Over-the-Fence Connection to Developer – Underground Connection	€612,900	Yes

SCHEDULE 1A: LINE STANDARD CHARGES

Standard Charges - Lines Summary		
Ref	Description	Standard Charge
5	38 kV SC Woodpole 150 mm ² AAAC 80°C	€101,330
7	MV SC Woodpole 150 mm ² AAAC / 92 mm ² SCA 65°C	€53,330

OVERARCHING ASSUMPTIONS

1. GENERAL

Line charges assume a typical ratio of poles/pole sets to masts. This ratio may significantly change depending on the routing.

Prices apply on a per km basis.

Charges do not include:

- Wayleave management flexibility payments (Access)
- Purchase of easements
- Shield wire
- High security lines

2. FOUNDATIONS

Foundations are included with all poles and masts.

3. OVERHEAD LINE RATINGS

- a. Higher rating assumes ambient temperature of 5°C; lower rating assumes ambient temperature of 25°C
- b. 250 kV BIL and Power Withstand of 95 kV correspond to the 52 kV IEC Voltage Class
- c. The system neutral is connected to earth through Peterson coils located at 110 kV/38 kV stations. On the occasion of a fault to the earth on one phase of the system, the voltage to earth on the healthy phases may exceed line voltage and this condition may be sustained for a considerable time (> 3 hours)

Individual Design Assumptions (continued)		
Ref	Description	Design Assumptions
5	38 kV SC Woodpole 150 mm ² AAAC 80°C	Max design voltage: 41.5 kV BIL: 250 kV Power frequency withstand voltage: 95 kV Load rating: 511 A to 604 A Fault current rating: 12 kA for 1 second Design wind speed: 36 m/s on bare conductor; 16 m/s on conductor with 2.5 cm radial ice; Minimum creepage: 960 mm on glass insulators; 1280 mm on polymeric insulators Poles: 10.0/km Mast: 0.0/km Earth Wire: No
7	MV SC Woodpole 150 mm ² AAAC / 92 mm ² SCA 65°C	Max design voltage: 21.5 kV BIL: 125 kV Power frequency withstand voltage: 50 kV Load rating: 412 A to 516 A Fault current rating: 11.5 kA for 1 second Design wind speed: 645 m/s on bare conductor; 16 m/s on conductor with 2.5 cm radial ice; Minimum creepage: 900 mm Poles: 11.0/km Mast: 0.0/km Earth Wire: No

SCHEDULE 1B: CABLE STANDARD CHARGES

Standard Charges - Cables Summary		
Ref	Description	Standard Charge
8	110 kV – 630 mm ² XLPE (AL) Single Circuit	€390,150
9	38 kV – 630 mm ² XLPE (AL) Single Circuit incl 38kV Arc Suppression Coil (ASC200A) on cable lengths >1kM	€128,510
10	MV – 400 mm ² XLPE (AL) Single Circuit	€40,160
12	110 kV Cable End Mast	€254,190
13a	110 kV Cable Civils (for refund purposes only)	€361,060
13b	38 kV Cable Civils (for refund purposes only)	€235,350
14	MV Cable Civils (for refund purposes only)	€166,170

OVERARCHING ASSUMPTIONS

1. GENERAL

Price for item 8 is for 1 km only. If more than 1 km of 110 kV cable is required, DSO will go to tender for the specific job and charge on a pass through basis.

Prices for items 9, 10, 13 & 14 apply on a per km basis.

2. CIVIL WORKS

Foundations are included with all Cable End Masts.

All other civil works, excavation, ducting, reinstatement, installation of plinths and bunds are carried out by the generator in accordance with ESB Networks specifications.

Items 13 and 14 are assumed to be Roadway Day and are for refund purposes only.

Individual Design Assumptions		
Ref	Description	Design Assumptions
8	110 kV – 630 mm ² XLPE (AL) Single Circuit	Max design voltage: 123 kV BIL: 550 kV Power frequency withstand voltage: 230 kV Load rating: 600 A Fault current rating: 26 kA for 1 second
9	38 kV – 630 mm ² XLPE (AL) Single Circuit	Max design voltage: 52 kV BIL: 250 kV Power frequency withstand voltage: 95 kV Load rating: 660 A Fault current rating: 20 kA for 1 second Includes cost of fibre optic cable Includes pro-rata portion of 38kV Arc Suppression Coil (ASC 200A) costs (approx 8% per kM) on 38kV Cable lengths > 1km Installation of ASC in an existing substation, on plinth in an oil-tight bund (by generator) Connection to the power transformer via mixture of underground cable and overhead conductor Based on standard layout, elevation and electrical schematic drawings. Cost exclude civil works for plinth & bund
10	MV – 400 mm ² XLPE (AL) Single Circuit	Max design voltage: 22 kV BIL: 125 kV Power frequency withstand voltage: 50 kV Load rating: 500 A Fault current rating: 20 kA for 1 second

SCHEDULE 1C: 110 KV STATION STANDARD CHARGES

Standard Charges – 110 kV Stations Summary		
Ref	Description	Standard Charge
18	110 kV/38 kV 63 MVA Green Field Transformer Package	€1,787,950
19	110 kV/38 kV 31.5 MVA Green Field Transformer Package	€1,472,180
20	110 kV/MV 20 MVA Green Field Transformer Package	€1,176,870
21	110 kV/MV 31.5 MVA Green Field Transformer Package	€1,353,730
23	Uprate 2*31.5 MVA to 2*63 MVA Station	€3,785,390
24	Civil works for a Typical Outdoor 110 kV Station Based on the layout of Item 15 (for refund purposes only)	€1,148,040

OVERARCHING ASSUMPTIONS

1. GENERAL

All electrical connections are assumed to be standard.

Where a charge involves installation of equipment in an existing station, it is assumed that:

- adequate space is available both electrically and physically,
- common services including protection and earth grids are adequate,
- busbar protection is in place and adequate to cover new bays,
- remote end works are not included,
- current standard contracts for switchgear can be drawn down i.e. the existing station does not require the procurement of non-standard switchgear to facilitate installation in the existing space,

except where these items are specifically mentioned as allowed for in the charge.

2. CIVIL WORKS

No civil works are allowed for in charges 15 - 23.

18 110 kV/38 kV 63 MVA Green Field Transformer Package

Standard Charge

€1,787,950

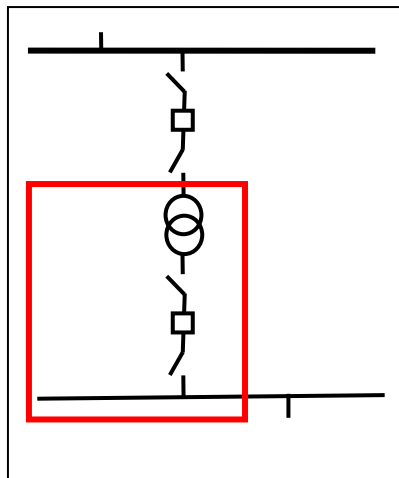

Electrical Assets [Including Design and Commissioning]

(1 off) 38 kV Transformer Bay, (1 off) 63 MVA 110/38 kV Transformer and 38 kV Single Busbar 2-bay extension including:

Disconnects + Steelwork

CTs + Steelwork

Control Cabling (Various)

Circuit Breakers

C&P Relays & Panel

Surge Arrestors + Steelwork

Transformer

CT & VT C&P Marshalling Boxes

Busbar + Steelwork

Neutral Treatment

Assumptions: Outdoor station.

19. 110 kV/38 kV 31.5 MVA Green Field Transformer Package

Standard Charge

€1,472,180

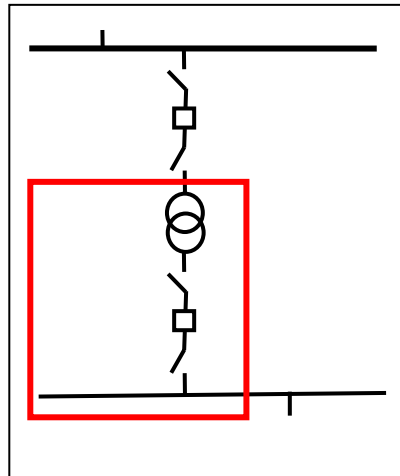

Electrical Assets [Including Design and Commissioning]

(1 off) 38 kV Transformer Bay, (1 off) 31.5 MVA 110/38 kV Transformer and 38 kV Single Busbar 2-bay extension including:

Disconnects + Steelwork

CTs + Steelwork

Control Cabling (Various)

Circuit Breakers

C&P Relays & Panel

Surge Arrestors + Steelwork

Transformer

CT & VT C&P Marshalling Boxes

Busbar + Steelwork

Neutral Treatment

Assumptions: Outdoor station.

20. 110 kV/MV 20 MVA Green Field Transformer Package

Standard Charge

€1,176,870

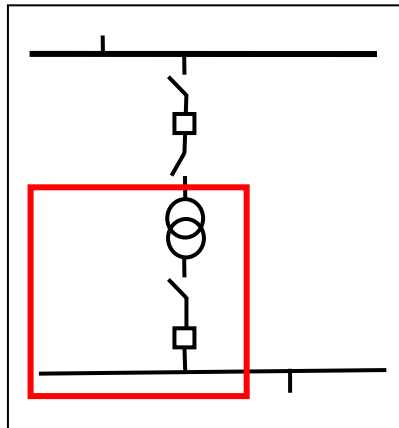

Electrical Assets [Including Design and Commissioning]

(1 off) MV Transformer Bay, (1 off) 20 MVA 110/MV Transformer and MV Busbar extension including:

Disconnects	CTs & VTs	Surge Arrestors + Steelwork
Circuit Breaker	C&P Relays & Panel	Conductor
Transformer	CT & VT C&P Marshalling Boxes	Busbar + Steelwork
Neutral Treatment	Control Cabling (Various)	

Assumptions: MV busbar is indoor.

21 110 kV/MV 31.5 MVA Green Field Transformer Package
Standard Charge €1,353,730

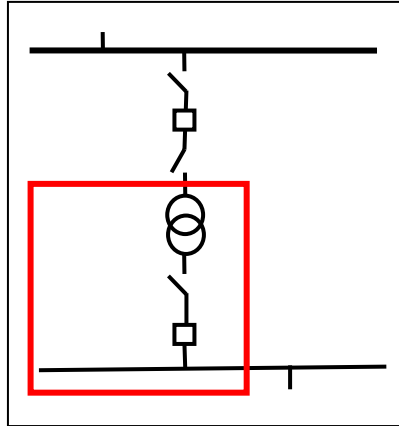

Electrical Assets [Including Design and Commissioning]

(1 off) MV Transformer Bay, (1 off) 31.5 MVA 110/MV Transformer and MV Busbar extension including:

Disconnects	CTs & VTs	Surge Arrestors + Steelwork
Circuit Breaker	C&P Relays & Panel	Conductor
Transformer	CT & VT C&P Marshalling Boxes	Busbar + Steelwork
Neutral Treatment	Control Cabling (Various)	

Assumptions: MV busbar is indoor.

23 Uprate 2*31.5 MVA to 2*63 MVA Substation

Standard Charge

€3,785,390

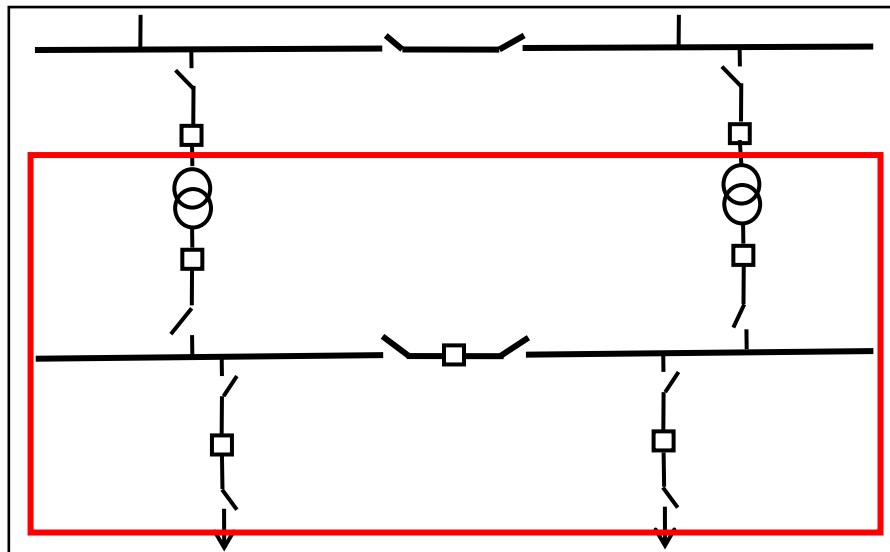

Electrical Assets [Including Design and Commissioning]

(2 off) 63 MVA 110/38 kV Transformers, (2 off) 38 kV Transformer Bays, (2 off) 38 kV Line Bays, (1 off) 38 kV Sectionaliser Bay and uprated 38 kV Busbar including:

Transformers	CTs & VTs + Steelwork	Impedance Protection
Bund Pumps	CT & VT C&P Marshalling Boxes	Control Cabling (Various)
Disconnects + Steelwork	Insulator Posts + Steelwork	Conductors & Headgear
Circuit Breakers	Surge Arrestors + Steelwork	

(2 off) 110 kV Transformer Bays Protection Upgrading:

Transformer Differential Protection	Impedance Protection	Control Cabling (Various)
	Overcurrent Protection	C&P Marshalling Boxes

Telecoms: Non-SCS

Assumptions: Lightning protection system not included.

BSM metering included.

No change required to ASC or to 38 kV busbar gantries and foundations.

38 kV bays are pedestal mounted AIS.

No change required to 110 kV neutral treatment.

Existing 38 kV protection to be retained.

Retirement of all upgraded equipment except the transformers is included.

24. Civil Works for a Typical Outdoor 110 kV Station

Indicative Civils Costs for Refund Purposes Only

€1,148,040

Assumptions: . This charge is based on the civils cost estimate of a typical 110kV AIS station design of the discontinued charge 'New 110 kV AIS "H-Type" Single Busbar Outdoor Station (Strung Busbar)" (previous GSC ref 15).

SCHEDULE 1D: 38KV STATION STANDARD CHARGES

Standard Charges – 38 kV Stations Summary		
Ref	Description	Standard Charge
26	5 MVA 38 kV/MV Green Field Transformer Package	€833,270
28	15 MVA 38 kV/MV Green Field Transformer Package	€1,047,000
29	Install 5 MVA 38 kV/MV Transformer into Existing Station with 38 kV Busbar Extension	€873,120
30	Install 10 MVA 38 kV/MV Transformer into Existing Station with 38 kV Busbar Extension	€956,880
31	Install 5 MVA 38 kV/MV Transformer into Existing Station without 38 kV Busbar Extension	€809,130
32	Install 10 MVA 38 kV/MV Transformer into Existing Station without 38 kV Busbar Extension	€892,900
33	Uprate 2 * 5 MVA station to 2 * 10 MVA	€2,014,780
34	Civil Works for a Typical Outdoor 38 kV Station (for refund purposes only)	€647,060

OVERARCHING ASSUMPTIONS

1. GENERAL

All electrical connections are assumed to be standard.

Where a charge involves installation of equipment in an existing station, it is assumed that:

- adequate space is available both electrically and physically,
- common services including protection and earth grids are adequate,
- busbar protection is in place and adequate to cover new bays,
- remote end works are not included,
- current standard contracts for switchgear can be drawn down i.e. the existing station does not require the procurement of non-standard switchgear to facilitate installation in the existing space, except where these items are specifically mentioned as allowed for in the charge.

2. CIVIL WORKS

No civil works are allowed for in charges 25 - 33.

26. 5 MVA 38 kV/MV Green Field Transformer Package

Standard Charge

€833,270

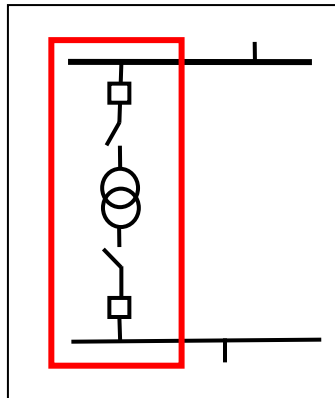

Electrical Assets [Including Design and Commissioning]

(1 off) 5 MVA Transformer, (1 off) 38 kV Transformer Bay including Busbar and (1 off) MV Transformer Bay including Busbar including:

Transformer	CTs & VTs	Surge Arrestors
Neutral Treatment	CT & VT C&P Marshalling Boxes	Transformer Bay Busbar +
Bund Pump	Control Cabling (Various)	Steelwork
Disconnects	C&P Relays & Panel	Conductor
Circuit Breakers		

Telecoms: SCS

Assumptions: Installation in a new 110 kV or 38 kV station. MV Busbar is indoor.

28 15 MVA 38 kV/MV Green Field Transformer Package

Standard Charge

€1,047,000

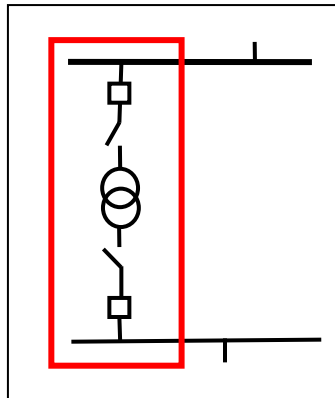

Electrical Assets [Including Design and Commissioning]

(1 off) 15 MVA Transformer, (1 off) 38 kV Transformer Bay including Busbar and (1 off) MV Transformer Bay including Busbar including:

Transformer	CTs & VTs	Surge Arrestors
Neutral Treatment	CT & VT C&P Marshalling Boxes	Transformer Bay Busbar +
Bund Pump	Control Cabling (Various)	Steelwork
Disconnects	C&P Relays & Panel	Conductor
Circuit Breakers		

Telecoms: SCS

Assumptions: Installation in a new 110 kV or 38 kV station. MV Busbar is indoor.

29 Install 5 MVA 38 kV/MV Transformer into Existing Station with 38 kV Busbar Extension

Standard Charge

€873,120

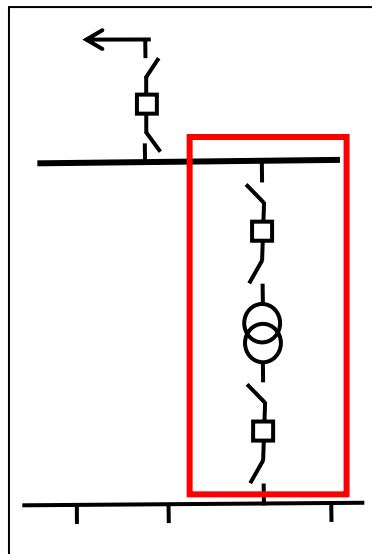

Electrical Assets [Including Design and Commissioning]

(1 off) 5 MVA 38 kV/MV Transformer, (1 off) 38 kV Transformer Bay, (1 off) MV Transformer Bay and 38 kV Busbar Extension including:

Transformer	AIS Circuit Breakers	Earths
Neutral Treatment	CTs & VTs	Conductors
Bund Pump	Surge Arrestors	38 kV & MV Bay Steelwork
Control Cabling (Various)	C&P Relays & Panels	38 kV Busbar & Steelwork
Disconnects	CT & VT C&P Marshalling Boxes	

30 Install 10 MVA 38 kV/MV Transformer into Existing Station with 38 kV Busbar Extension

Standard Charge

€956,880

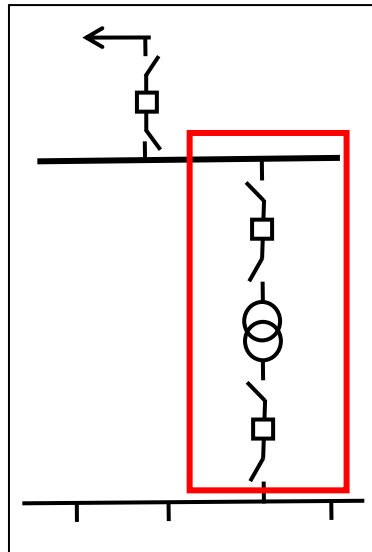

Electrical Assets [Including Design and Commissioning]

(1 off) 10 MVA 38 kV/MV Transformer, (1 off) 38 kV Transformer Bay, (1 off) MV Transformer Bay and 38 kV Busbar Extension including:

Transformer	AIS Circuit Breakers	Earths
Neutral Treatment	CTs & VTs	Conductors
Bund Pump	Surge Arrestors	38 kV & MV Bay Steelwork
Control Cabling (Various)	C&P Relays & Panels	38 kV Busbar & Steelwork
Disconnects	CT & VT C&P Marshalling Boxes	

31 Install 5 MVA 38 kV/MV Transformer into Existing Station without 38 kV Busbar Extension

Standard Charge

€809,130

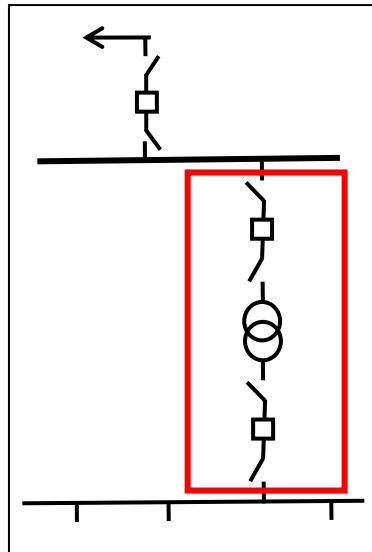

Electrical Assets [Including Design and Commissioning]

(1 off) 5 MVA 38 kV/MV Transformer, (1 off) 38 kV Transformer Bay and (1 off) MV Transformer Bay including:

Transformer	AIS Circuit Breakers	Surge Arrestors
Neutral Treatment	CTs & VTs	Earths
Bund Pump	C&P Relays & Panels	Conductors
Control Cabling (Various)	CT & VT C&P Marshalling Boxes	38kV & MV Bay Steelwork
Disconnects		

Assumptions: Spare 38 kV bay available with short cable run to transformer position.

32. Install 10 MVA 38 kV/MV Transformer into Existing Station without 38 kV Busbar Extension

Standard Charge

€892,900

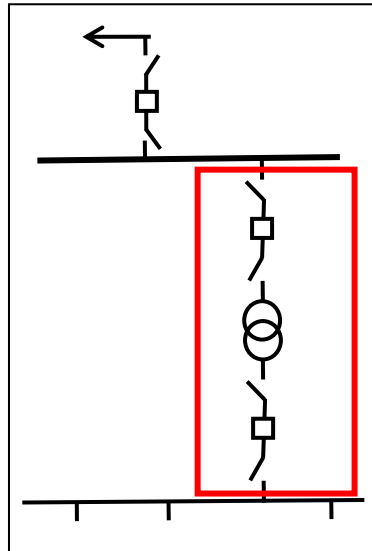

Electrical Assets [Including Design and Commissioning]

(1 off) 10 MVA 38 kV/MV Transformer, (1 off) 38 kV Transformer Bay and (1 off) MV Transformer Bay including:

Transformer	AIS Circuit Breakers	Surge Arrestors
Neutral Treatment	CTs & VTs	Earths
Bund Pump	C&P Relays & Panels	Conductors
Control Cabling (Various)	CT & VT C&P Marshalling Boxes	38kV & MV Bay Steelwork
Disconnects		

Assumptions: Spare 38kV bay available with short cable run to transformer position.

33 Uprate 2 * 5 MVA station to 2 * 10 MVA

Standard Charge

€2,014,780

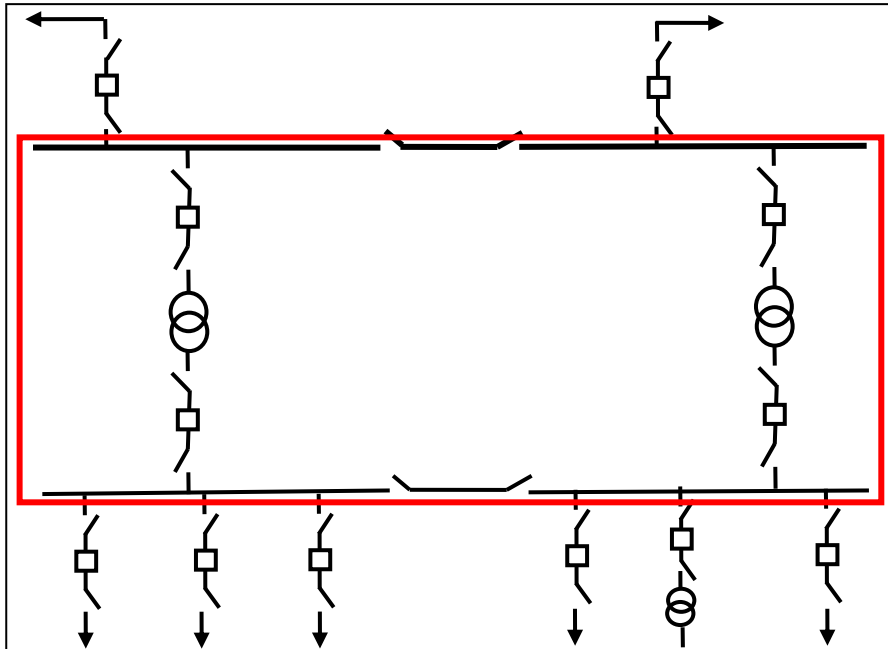

Electrical Assets [Including Design and Commissioning]

(2 off) 38 kV Transformer Bays, 38 kV Busbar uprating, (2 off) 10 MVA 38 kV/MV Transformers, (2 off) MV Transformer Bays, MV Busbar uprating and Control Room including:

AIS Circuit Breakers	Control Cabling (Various)	Busbar & Steelwork
Transformers	C&P Relays	Earths
Bund Pumps	C&P Mimic & Signal Boxes	Battery Charger
Neutral Treatment	C&P Marshalling Boxes	Distribution Board

Telecoms: RTU

Assumptions: Fit-out of control building with AAP, DC System mimics etc. included but transfer of remaining substation protection for other lines/transformers from existing control room into the proposed control room is not included.

Retirement of all old plant which is not being reused (excepting transformers) included.

Reusing 38kV disconnects, CTs & VTs.

34 Civil Works for a Typical Outdoor 38kV Station

Indicative Civils Costs for Refund Purposes Only

€647,060

Assumptions: This charge is based on the civils cost estimate of or typical 38kV AIS station design of the discontinued charge "New 2*5 MVA Station" (*previous GSC ref 25*)

SCHEDULE 1E: MISCELLANEOUS STATION STANDARD CHARGES

Standard Charges – Miscellaneous Stations Summary		
Ref	Description	Standard Charge
35	New 110 kV AIS Line bay in existing 110 kV Single Busbar Outdoor Station	€747,180
36	38 kV Cubicle in 38 kV Station	€275,450
37	38 kV Cubicle in 110 kV Station	€318,280
38	MV Cubicle in 110 kV or 38 kV station	€219,090
55	Installation of 110kV NVD (Neutral Voltage Displacement) Protection (on both Transformers)	€198,430

OVERARCHING ASSUMPTIONS

1. GENERAL

All electrical connections are assumed to be standard.

Where a charge involves installation of equipment in an existing station, it is assumed that:

- adequate space is available both electrically and physically,
- common services including protection and earth grids are adequate,
- busbar protection is in place and adequate to cover new bays,
- remote end works are not included,
- current standard contracts for switchgear can be drawn down i.e. the existing station does not require the procurement of non-standard switchgear to facilitate installation in the existing space,

Except where these items are specifically mentioned as allowed for in the charge.

2. CIVIL WORKS

No Civil works are allowed for in charges 35-38 and 55

35. New 110 kV AIS Line Bay in Existing 110 kV Single Busbar Outdoor Station

Standard Charge

€747,180

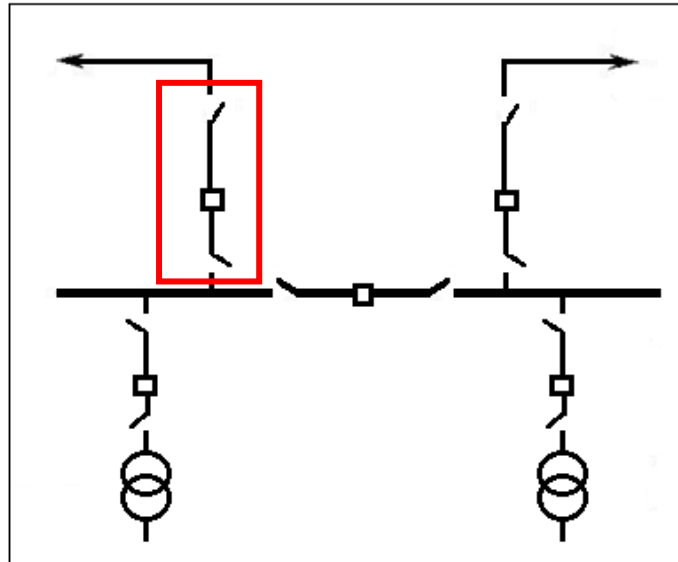

Electrical Assets [Including Design and Commissioning]

(1 off) 110 kV Line Bay including:

Disconnects + Steelwork

Surge Arrestors + Steelwork

CT & VT C&P Marshalling Boxes

Circuit Breaker

Insulator Posts + Steelwork

C&P Relays & Panel

CTs & VTs + Steelwork

Control Cabling (Various)

Conductor

Telecoms: SCS /RTU connection works

Assumptions: Strung/tubular busbar.

36 38 kV Cubicle in 38 kV Station

Standard Charge

€275,450

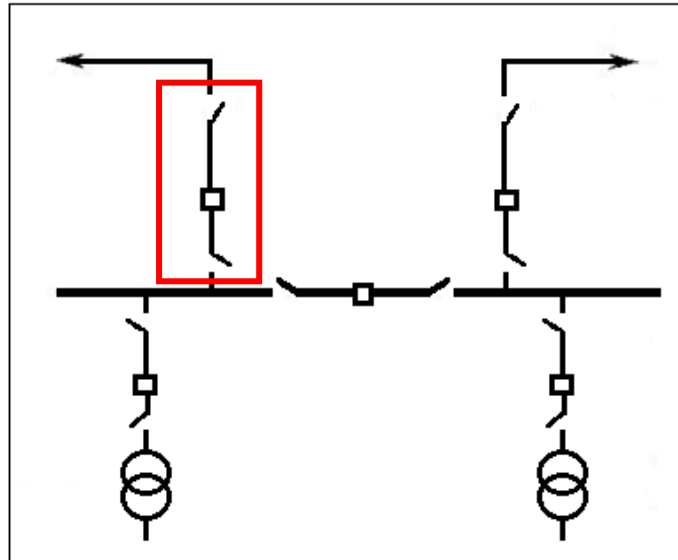

Electrical Assets [Including Design and Commissioning]

(1 off) 38 kV Cubicle including:

Disconnects	Control Cabling (Various)	Conductor
AIS Circuit Breaker	CT & VT C&P Marshalling Boxes	Bay Busbar & Steelwork
CTs & VTs	C&P Relays & Panel	

Telecoms: SCS /RTU connection works

Assumptions: Outdoor ground mounted cubicle;
Spare 38kV bay available;
Max design voltage 52kV;
BIL 250kV;
Power frequency withstand voltage of 95kV;
Busbar load rating 1000-1250A;
Busbar fault rating 20kA for 1 second.

37. 38 kV Cubicle in 110 kV Station

Standard Charge

€318,280

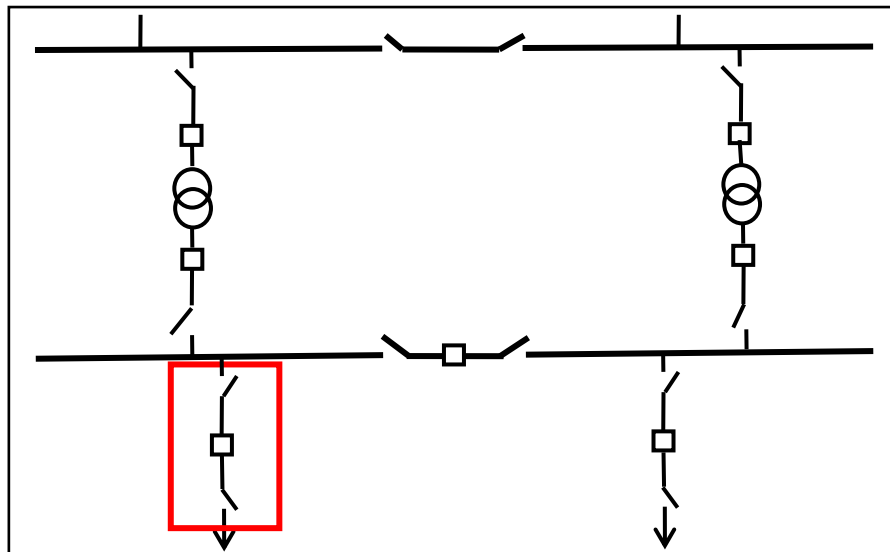

Electrical Assets [Including Design and Commissioning]

(1 off) 38 kV Cubicle including:

- | | | |
|---------------------|-----------------------------|--------------------|
| Disconnects | Control Cabling (Various) | C&P Relays & Panel |
| AIS Circuit Breaker | CT & VT C&P Marshalling Box | Conductor |
| CTs & VTs | | |

Telecoms: SCS /RTU connection works

Assumptions: Outdoor ground mounted cubicle;
Spare 38kV bay available;
Max design voltage 52kV;
BIL 250kV;
Power frequency withstand voltage of 95kV;
Busbar load rating 1000-1250A;
Busbar fault rating 20kA for 1 second.

38. MV Cubicle in 110 kV or 38 kV Station

Standard Charge

€219,090

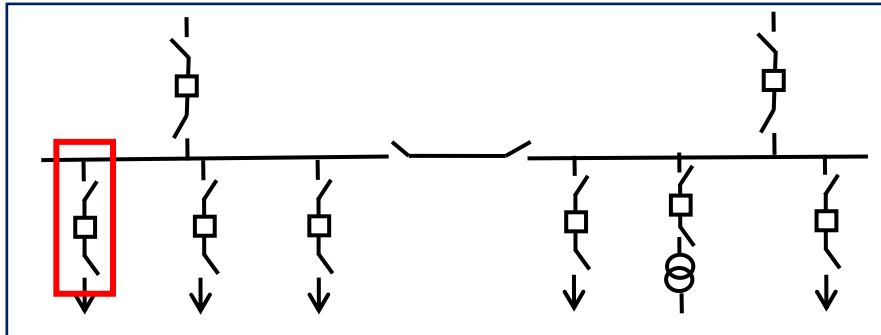

Electrical Assets [Including Design and Commissioning]

(1 off) MV Cubicle including:

AIS Circuit Breaker

CTs & VTs

Control Cabling (Various)

Disconnects

MV Busbar & Steelwork

C&P Relays & Panel

Telecoms: SCS

Assumptions: Existing MV busbar available;

Spare bay available;

Bay has all standard MV functionality;

Max design voltage 24kV;

BIL 125kV;

Power frequency withstand voltage 50kV;

Busbar load rating 2000A, fault rating 20kA for 1 second;

Protection relays to include earth fault, overcurrent, directional sensitive earth fault.

Individual Design Assumptions		
Ref	Description	Design Assumptions
55	Installation of 110kV NVD (Neutral Voltage Displacement) Protection (on both Transformers)	110 kV Neutral VT installed on a base adjacent to power transformer in an existing substation Connection to the power transformer via overhead conductor NVD protection relay installed in a new cabinet Based on standard layout, elevation and electrical schematic drawings. Excludes civil works.

SCHEDULE 1F: METERING STANDARD CHARGES

Standard Charges – Metering Summary		
Ref	Description	Standard Charge
41	38 kV Meter and Power Quality	€57,550
42	MV Metering and Power Quality < 10 MVA	€27,870
43	MV Metering and Power Quality < 10 MVA (where MV CB is being charged as part of EGIP installation, no need for KKK)	€21,380
44	MV Metering and Power Quality >= 10 MVA	€29,600
45	MV Metering and Power Quality >= 10 MVA (where CB is being charged as part of EGIP installation, no need for KKK)	€23,090

ASSUMPTIONS

- Metering costs are included in all charges (41-45).
These assume only one set of meters installed.
In the case of > 10 MVA (i.e. charges 41, 44 & 45) the set also includes check meters.
In the event that additional meter sets are required (e.g. for reasons of supplier contracts) then additional charges will apply.
- CTs & VTs are included in all charges.
- Power quality meters and transducers are included in all charges.
- Charges 42 and 44 include KKK units. They assume EGIP not installed.

NOTE

The metering charges for Power Quality in items 41, 42, 43, 44, and 45 will change as the current Power Quality equipment is becoming obsolete and is subject to a tendering process. The revised charges will cover the costs for the new power quality metering technology, communication equipment, configuration and installation of communication equipment, and IT infrastructure and software licenses for the system management and data analysis. The annual Operation and Maintenance (O&M) charges will change to include the annual data communication costs for transmitting the power quality information from the power quality meters to the central database for data analysis.

Any Customer that pays their Second Stage Payment in 2019 will have the current Power Quality equipment installed and charged accordingly. Any Customer that pays its Second Stage Payment after 2019 may (at the discretion of ESB Networks) have the new Power Quality equipment installed and will be charged accordingly. These new rates will not be known until after the associated procurement process is complete.

SCHEDULE 1G: COMMUNICATIONS & PROTECTION STANDARD CHARGES

Standard Charges – Communications & Protection Summary		
Ref	Description	Standard Charge
46	Protection Implementation for MV Connections with MEC < 2 MW	€42,420
47	SCADA & Communications Implementation for MV Connections with MEC >= 2 MW	€61,900
49	Protection & Switchgear for Standard MV Connection (Basic G10 type Connection)	€55,070
50	Switchgear & Embedded Generation Interface Protection (EGIP) for an MV Connection (Full fit-out of Generator Sub Connection)	€224,560
50a	Switchgear & Embedded Generation Interface Protection (EGIP) for an MV Connection, Standard Module Substation	€287,010
51	Embedded Generation Interface Protection (EGIP) for a 38 kV Connection	€89,040
52	Embedded Generation Interface Protection (EGIP) for a 110 kV Connection	€96,550

ASSUMPTIONS

1. Embedded Generation Interface Protection (Charges 49-52) is designed to standard.
2. No civil works required.

Individual Design Assumptions		
Ref	Description	Design Assumptions
46	Protection Implementation for MV Connections with MEC < 2 MW	Nulec recloser to be installed Recloser to be installed between the metering CT/VT and the customer MV tail cables.
47	SCADA and Protection Implementation for MV Connections with MEC >= 2 MW	Nulec recloser to be installed as part of charge #49 Remote control facilities for NULEC recloser required Recloser to be installed between the metering CT/VT and the customer MV tail cables. Includes RTU, DSO SCADA & Polling Radio.
49	Protection & Switchgear for Standard MV Connection (Basic G10 type Connection)	Installation of Nulec recloser & RMU KKK Switch on purpose-built frame, including associated electrical cabling & terminations for basic G10 type connection. Recloser to be installed between the metering CT/VT and the customer MV tail cables
50	Switchgear & Embedded Generation Interface Protection (EGIP) for an MV Connection (Full fit-out of Generator Sub Connection)	Installation of EGIP protection & NX Plus Switchgear (Siemens type). Full electrical fit-out of a new purpose built mini-station building for generator connection at MV. Includes protection relays for MV EGIP, full cubicle Switchgear fit-out (NX Plus); AAP alarm panel, batteries, chargers, cabinets, distribution board, accessories, signals and telecommunications, for complete MV EGIP connection. Building and civils works by generator.
50a	Switchgear & Embedded Generation Interface Protection (EGIP) for an MV Connection, Standard Module Substation	ESB Networks Standard Module (ESB Networks switch room only) Installation of EGIP protection & NX Plus Switchgear (Siemens type). Full electrical fit-out of a new purpose built mini-station building for generator connection at MV. Includes protection relays for MV EGIP, full cubicle Switchgear fit-out (NX Plus); AAP alarm panel, batteries, chargers, cabinets, distribution board, accessories, signals and telecommunications, for complete MV EGIP connection. Foundation plinth civil works by generator customer.
51	Embedded Generation Interface Protection (EGIP) for a 38 kV Connection	Installation of EGIP protection only for generator connection at an existing 38kV station. Includes relays, cabinet, cabling, marshalling kiosk, and associated EGIP telecom works.
52	Embedded Generation Interface Protection (EGIP) for a 110 kV Connection	Installation of EGIP protection only for generator connection at an existing 110kV station. Includes relays, cabinet, cabling, marshalling kiosk, and associated EGIP telecom works.

SCHEDULE 1H: 38 KV CUSTOMER COMPOUND [AT GENERATOR SITE] STANDARD CHARGES

Standard Charges – 38 kV Customer Compound [At Generator Site] Summary		
Ref	Description	Standard Charge
53	ESB Networks Compound with Over-the-Fence Connection to Developer – Overhead Connection	€575,020
54	ESB Networks Compound with Over-the-Fence Connection to Developer – Underground Connection	€612,900

53. ESB Networks Compound with Over-the-Fence Connection to Developer – Overhead Connection

Standard Charge

€575,020

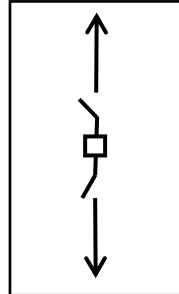

Electrical Assets [Including Design and Commissioning]

38 kV Compound Overhead to Overhead Connection including:

Busbar & Steelwork	C&P Relays & Marshalling Box	Metering
AIS Circuit Breaker	C&P Mimic & Signal Box	Battery System
VTs & CTs	Surge Arrestors	Conductor
Disconnects	Earth Grid	Mast
Control Cabling (Various)	CT/VT Metering	

Telecoms: RTU.

Assumptions: Incomer is overhead;
 Outgoer to customer may be either overhead or cable;
 Compound fencing and stoning will be put in place and a control room will be provided by the Generator.

Includes EGIP Protection at 38kV & Customer Interface Kiosk

54 ESB Networks Compound with Over-the-Fence Connection to Developer –Underground Connection

Standard Charge

€612,900

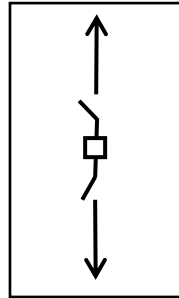

Electrical Assets [Including Design and Commissioning]

38 kV Compound Cable to Cable Connection including:

Busbar & Steelwork	C&P Relays & Marshalling Box	CT/VT Metering
AIS Circuit Breaker	C&P Mimic & Signal Box	Metering
VTs & CTs	Surge Arrestors	Battery System
Disconnects	Earth Grid	Cable
Control Cabling (Various)		

Telecoms: RTU.

Assumptions: Incomer is cable;
 Outgoer to customer may be either overhead or cable;
 Compound fencing and stoning will be put in place and a control room will be provided by the Generator.

Includes EGIP Protection at 38kV & Customer Interface Kiosk

Glossary

Acronym	Full Name
AAAC	All Aluminium Alloy Conductor
AAP	Alarm Annunciation Panel
AC	Alternating Current
ACSR	Aluminium Conductor Steel Reinforced
AIS	Air Insulated Switchgear
ASC	Arc Suppression Coil
BIL	Breakdown Insulation Level
C&P	Control and Protection
CB	Circuit Breaker
CER	Commission for Energy Regulation
CPI	Consumer Price Index
CRU	Commission for Regulation of Utilities
CT	Current transformer
DC	Direct Current
DSO	Distribution System Operator
EGIP	Embedded Generation Interface Protection
ESBN	ESB Networks DAC
GIS	Gas Insulated Switchgear
GPRS	General Package Radio Service
HICP	Harmonised Indexation of Consumer Prices
IEC	International Electro-Technical Commission
KKK	Reference to a particular type of switch
kV	Kilo Volts
kVA	Kilo Volt-Amperes
LCTA	Least Cost Technically Acceptable
MEC	Maximum Export Capacity
MV	Medium Voltage
MVA	Mega Volt-Amperes
MW	Megawatts
NES	Neutral Earth Switch
NULEC	Brand name of a particular recloser device with built in protection
NVD	Neutral Voltage Displacement
RTU	Remote Terminal Unit
SC	Single Circuit
SCA	Steel Cored Aluminium
SCADA	Supervisory Control And Data Acquisition
SCS	Station Control System
SLD	Single Line Diagram
TSO	Transmission System Operator
VAT	Value Added Tax
VT	Voltage Transformer
XLPE (AL)	Cross-Linked Polyethylene (Aluminium)